

# Turmdrehkran

Tower Crane / Grue à tour / Gru a torre / Grúa torre  
Guindaste de torre / Башенный поворотный кран

## 132 EC-H 8 FR.tronic®

## 132 EC-H 8 Litronic®

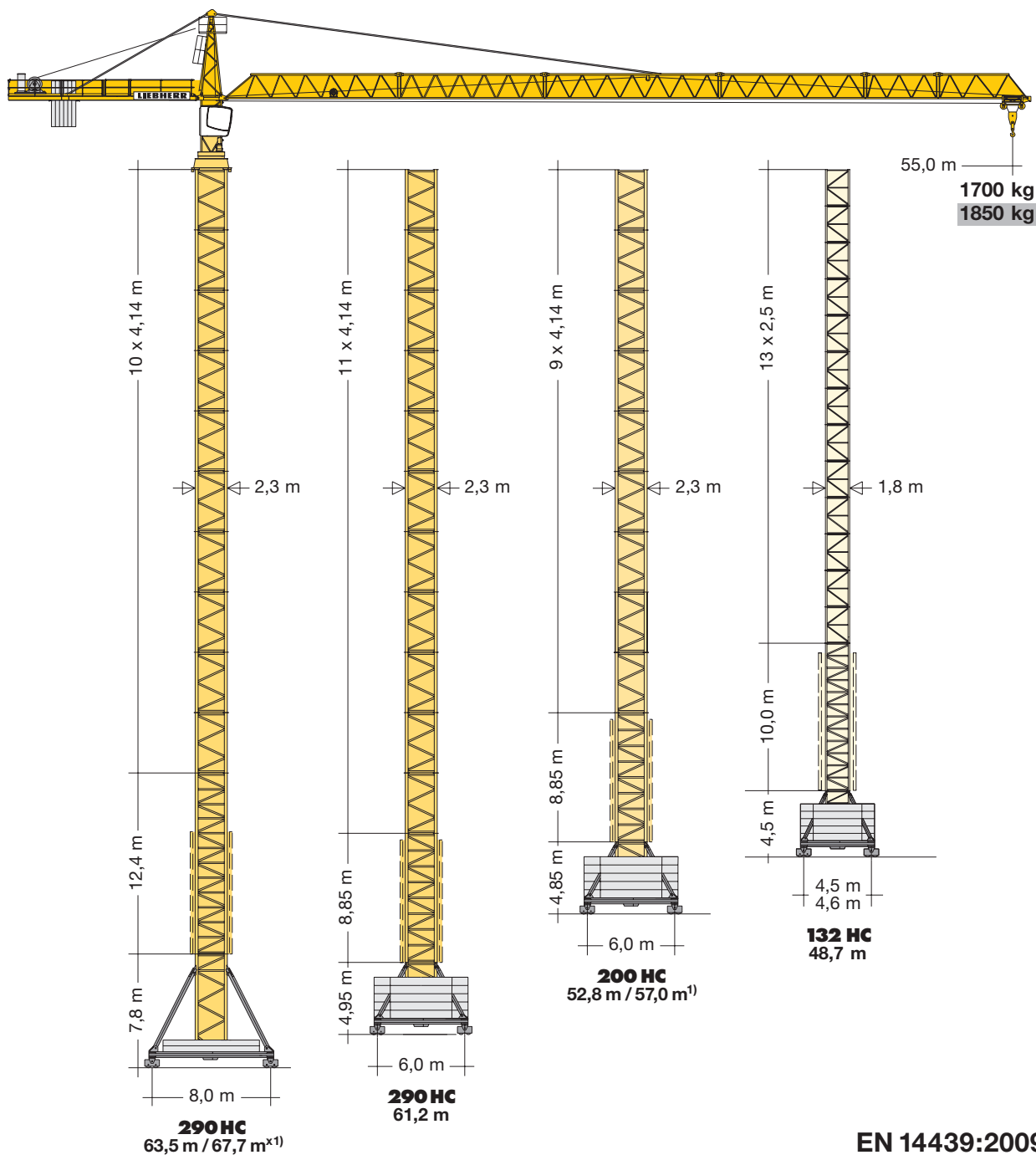

EN 14439:2009-C25

# LIEBHERR

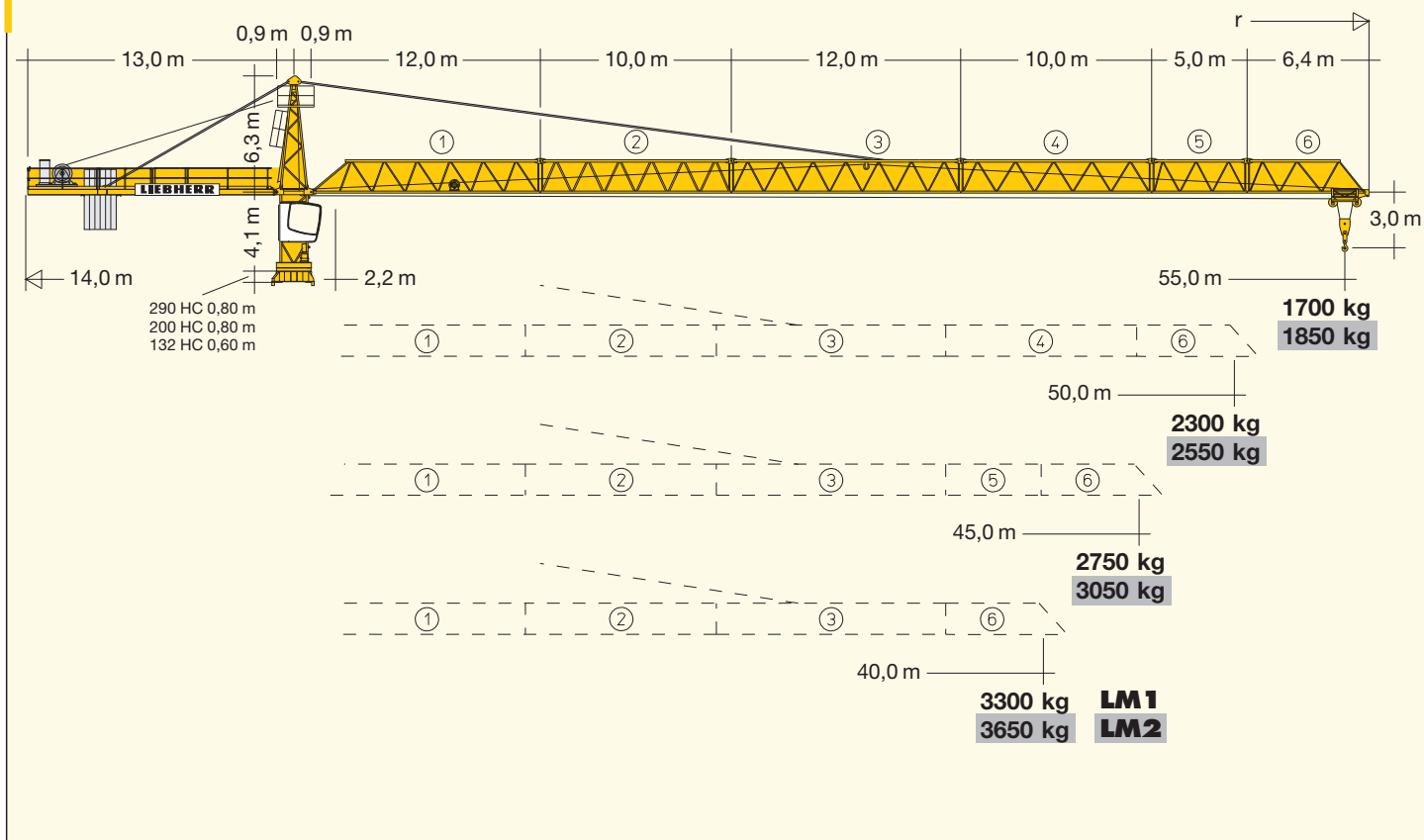

## Hubhöhe

Hoisting height / Hauteur sous crochet / Altezza di sollevamento  
 Altura bajo gancho / Altura de montagem / Высота подъема

		132 HC											
C 25	14	-	-	-	-	45,1*	-	43,8*	47,0*	-	-	-	-
	13	45,5*	48,7*	45,0*	48,2*	42,6*	45,8*	41,3*	44,5*	42,7*	-	42,5*	-
	12	43,0*	46,2*	42,5*	45,7*	40,1*	43,3*	38,8*	42,0*	40,2*	43,4*	40,0*	43,2*
	11	40,5	43,7	40,0	43,2	37,6	40,8	36,3*	39,5	37,7*	40,9*	37,5*	40,7*
	10	38,0	41,2	37,5	40,7	35,1	38,3	33,8	37,0	35,2	38,4*	35,0	38,2
	9	35,5	38,7	35,0	38,2	32,6	35,8	31,3	34,5	32,7	35,9	32,5	35,7
	8	33,0	36,2	32,5	35,7	30,1	33,3	28,8	32,0	30,2	33,4	30,0	33,2
	7	30,5	33,7	30,0	33,2	27,6	30,8	26,3	29,5	27,7	30,9	27,5	30,7
	6	28,0	31,2	27,5	30,7	25,1	28,3	23,8	27,0	25,2	28,4	25,0	28,2
	5	25,5	28,7	25,0	28,2	22,6	25,8	21,3	24,5	22,7	25,9	22,5	25,7
	4	23,0	26,2	22,5	25,7	20,1	23,3	18,8	22,0	20,2	23,4	20,0	23,2
	3	20,5	23,7	20,0	23,2	17,6	20,8	16,3	19,5	17,7	20,9	17,5	20,7
	2	18,0	21,2	17,5	20,7	15,1	18,3	13,8	17,0	15,2	18,4	15,0	18,2
	1	15,5	18,7	15,0	18,2	12,6	15,8	11,3	14,5	12,7	15,9	12,5	15,7
	0	a) 13,0	b) 16,2	a) 12,5	b) 15,7	a) 10,1	b) 13,3	a) 8,8	b) 12,0	a) 10,2	b) 13,4	a) 10,0	b) 13,2
		m		m		m		m		m		m	

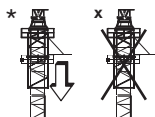

**Weitere Hubhöhen, Auslegerlängen sowie Klettern im Gebäude auf Anfrage.** / Further hoist heights and jib lengths as well as climbing inside the building on request. / Autres hauteurs sous crochet et longueurs de flèche ainsi que hissage dans le bâtiment sur demande. / Ulteriori altezze gancio, lunghezze bracci così come telescopaggio all'interno dell'edificio: su richiesta. / Para alturas bajo gancho superiores, otros alcances y trepado en el interior del edificio, consultar. / Outras alturas de elevação, comprimentos de lança e subida no edifício: sob consulta. / Другие высоты подъема, длины стрелы и самоподъем в здании – по запросу.

# Ausladung und Tragfähigkeit

Radius and capacity / Portée et charge / Sbraccio e portata  
Alcances y cargas / Alcance e capacidade de carga / Вылет и грузоподъемность

		<b>132 EC-H 8 FR.tronic®</b>																		
m	r	m/kg	m/kg																	
			17,0	19,0	21,0	23,0	25,0	27,0	29,0	31,0	33,0	35,0	37,0	40,0	43,0	45,0	47,0	50,0	53,0	55,0
55,0	(r=56,4)	2,2-15,5 8000	7210	6370	5680	5120	4650	4240	3900	3600	3330	3100	2890	2620	2380	2240	2120	1940	1790	1700
50,0	(r=51,4)	2,2-17,5 8000	8000	7310	6540	5900	5360	4910	4510	4170	3870	3610	3370	3060	2800	2640	2490	2300		
45,0	(r=46,4)	2,2-18,1 8000	8000	7580	6780	6120	5560	5090	4690	4330	4020	3750	3510	3190	2910	2750				
40,0	(r=41,4)	2,2-18,6 8000	8000	7810	6990	6310	5740	5260	4840	4480	4160	3880	3630	3300						

**LM1**

# Hubhöhe

Hoisting height / Hauteur sous crochet / Altezza di sollevamento  
Altura bajo gancho / Altura de montagem / Высота подъема

C 25	<b>200 HC</b>			<b>290 HC</b>				
	13	-	-	-	-	-	-	-
12	-	-	-	60,7*	64,3*	-	-	-
11	56,5*	-	-	56,5*	60,1*	-	-	67,7 <sup>x1)</sup>
10	52,4*	57,0 <sup>x1)</sup>	53,7*	52,4	56,0	61,2*	-	63,5*
9	48,2	52,8*	49,6	48,2	51,8	53,0	53,6*	59,4
8	44,1	48,7	45,4	44,1	47,7	48,8	45,4	48,9
7	40,0	44,5	41,3	40,0	43,6	44,7	41,2	44,8
6	35,8	40,4	37,2	35,8	39,4	40,5	37,1	40,7
5	31,7	36,3	33,0	34,7	35,3	36,4	33,0	36,5
4	27,5	32,1	28,9	27,5	31,1	32,3	28,8	32,4
3	23,4	28,0	24,7	23,4	27,0	28,1	24,7	28,2
2	19,3	23,8	20,6	19,3	22,9	24,0	20,5	24,1
1	15,1	19,7	16,5	15,1	18,7	19,8	16,4	20,0
0	11,0	15,6	12,3	11,0	14,6	15,7	12,3	15,8

r = 12,0 m

r = 12,5 m

r = 18,0 m

<sup>1)</sup> Ohne Fahrwerke / Without Travel Gear / Sans boogie / Senza dispositivi di traslazione / Sin cajas de traslación  
Sem mecanismo de translação / Без механизмов передвижения

# Ausladung und Tragfähigkeit

Radius and capacity / Portée et charge / Sbraccio e portata  
Alcances y cargas / Alcance e capacidade de carga / Вылет и грузоподъемность

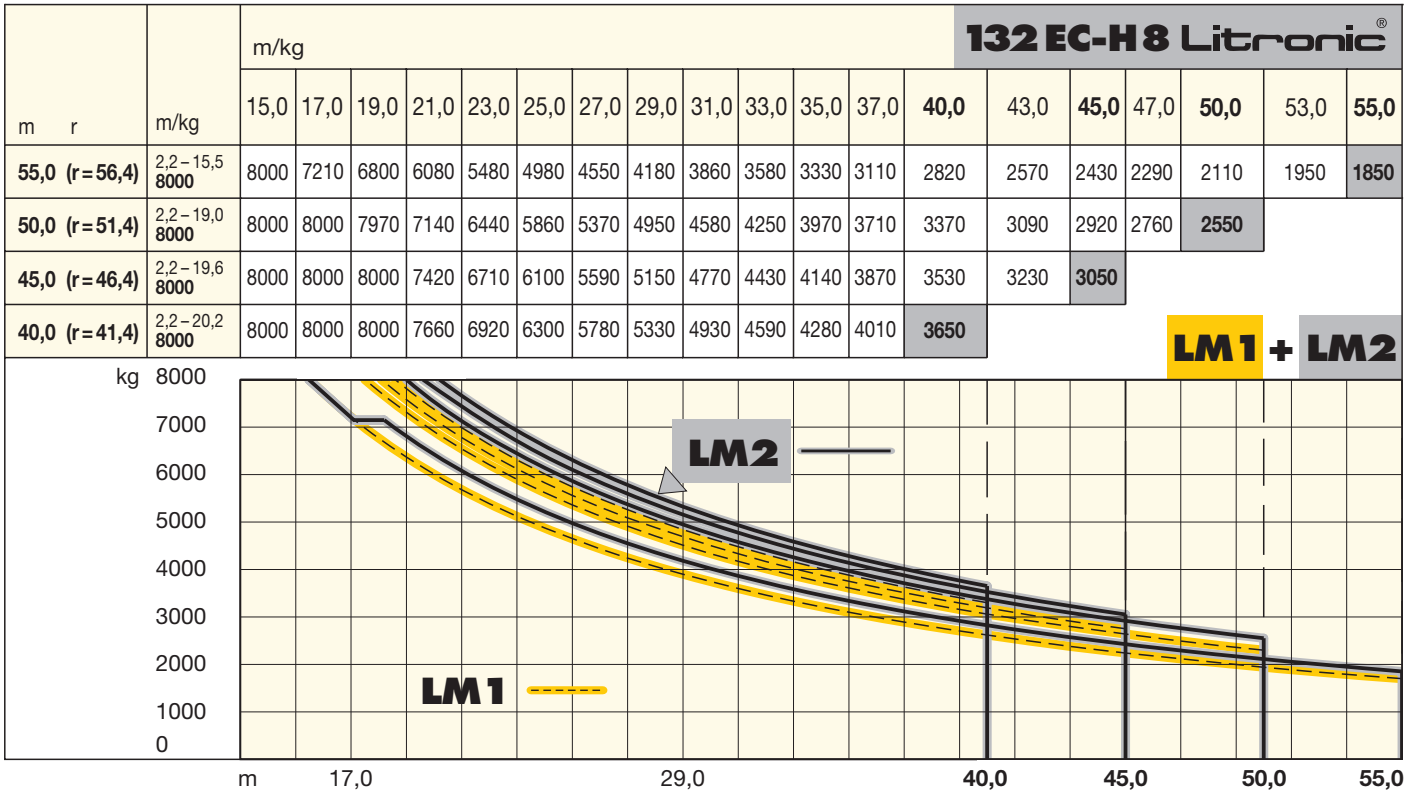

**LM1 + LM2**

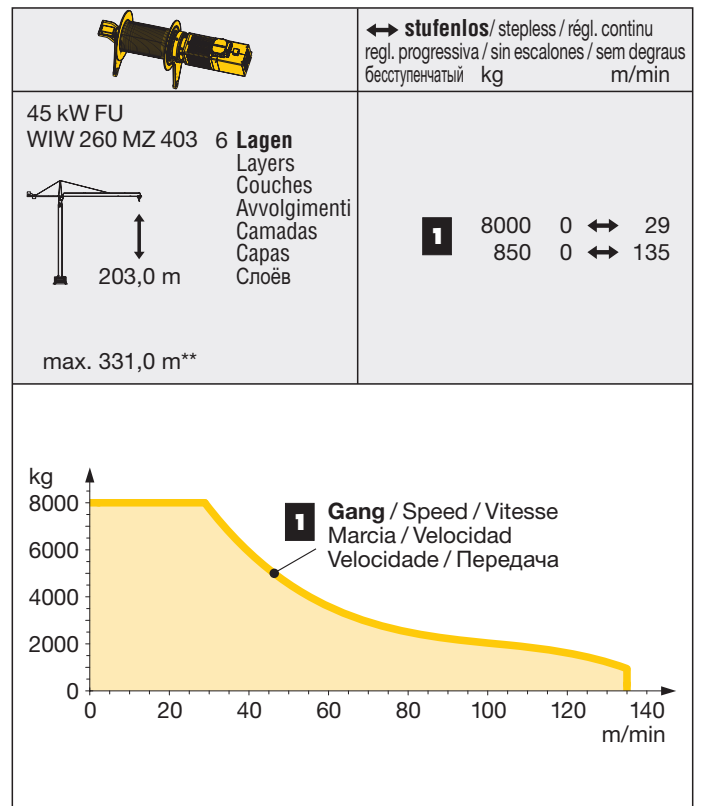
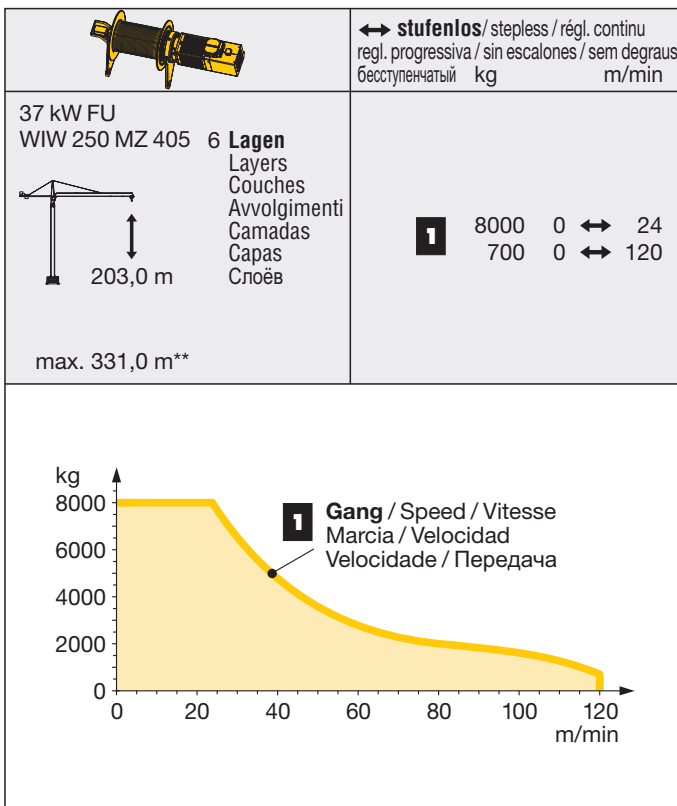

# Antriebe FR.tronic®/Litronic®

Driving units / Mécanismes d entraînement  
Meccanismi / Mecanismos / Mecanismos / Приводы

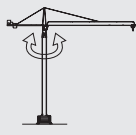

\*\* Weitere Hublastdaten: siehe Betriebsanleitung. / Further hoist load data: see instruction manual. / Autres données de la charge de levage: voir manuel d'instruction. / Altri dati sui carichi sollevati: consultare il manuale d'istruzione. / Alturas bajo granco superiores según manual. / Outras tabelas de carga: consultar manual de instruções. / Другие данные по весу поднимаемых грузов: см. инструкцию по эксплуатации.

**LM 2** Abweichende Geschwindigkeiten und Betriebsbedingungen. / Variant speeds and service conditions. / Vitesses et conditions de fonctionnement différentes. / Differenti velocità e condizioni di funzionamento. / Otras velocidades y características de funcionamiento. / Outras velocidades e características de funcionamento. / Нестандартные скорости и условия эксплуатации.

	0 ↔ 0,8 U/min sl./min tr./min	1 x 7,5 kW FU
	0 ↔ 100,0 m/min	5,5 kW FU
	25,0 m/min	2 x 4,0 kW (132 HC) 2 x 7,5 kW (290 HC) 2 x 5,5 kW (200 HC)

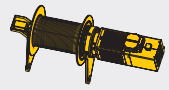











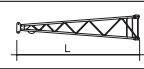





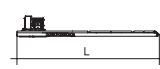

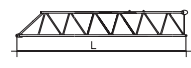

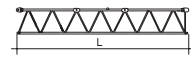
	<b>kVA</b>	
	37 kW FU	45 kW FU
	47,0	54,0

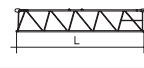







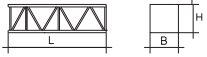

**Litronic: kVA** reduzierbar bei zu geringer Netz-Anschlussleistung, siehe BAL. / kVA can be reduced in case of too little power of the mains, see instruction manual. / kVA peut être réduit en cas de trop faible puissance du réseau, voir manuel d'instruction. / kVA riducibili in caso di potenza di rete ridotta (si veda manuale uso e manutenzione) / kVA variable para potencia de red demasiado pequeña, ver Manual de instrucciones. / kVA reduzível no caso de capacidade da rede elétrica muito baixa, ver manual de instruções. / Количество кВА может быть сокращено до минимальной общей потребляемой мощности, см. инструкцию по эксплуатации.

## Kolli-Liste

Packing List / Liste de colisage / Lista dei colli  
Lista de contenido / Lista de embalagem / Упаковочный лист

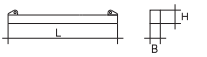
Montagegewichte: siehe Betriebsanleitung. / Erection weights: see instruction manual. / Poids de montage: voir manuel de service. / Pesì di montaggio: vedere manuale d'uso. / Pesos para el montaje: según manual. / Pesos de montagem: vejã-se as instruções p. uso. / Масса монтируемых частей: см. инструкцию по эксплуатации.

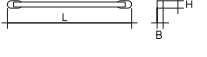
Kranoberteil		Upper part of crane / Partie supérieure de grue / Parte superiore della gru Parte superior grúa / Parte superior do guindaste / Верхняя часть крана			L (m)	B (m)	H (m)	kg*	
Pos. Item	Anz. Qty.	<b>Kabine mit Drehbühne</b> / Cabin with slewing platform Cabine avec ensemble mât-cabine / Cabina con piattaforma girevole / Plataforma de giro / Cabina com plataforma giratório / Кабина с поворотной платформой			132 HC	5,15	2,44	2,48	6900
Rep. Voce	Qta. Qta.				200 HC	6,00	2,74	2,65	7500
Ref. Cant.	Cant. Cant.				290 HC	6,00	2,74	2,65	7500
Pos. Cant.	Col-vo								
1	1								
2	1	<b>Turmspitze</b> / Tower head section / Porte-flèche Testa porta-braccio / Cabeza de torre / Cabeça de arpaio de lança / Оголовок башни				6,20	1,46	1,70	1470
3	1	<b>Hubwerkseinheit 37 kW</b> / Hoist gear unit / Treuil de levage / Gruppo meccanismo sollevamento / Mecanismo de elevación / Grupo de mecanismo elevatório / Блок грузовой лебедки				2,34	2,20	1,70	2600
4	1	<b>Gegenausleger</b> / Counter-jib / Contre-flèche Controfreccia / Contrapluma / Contra-lança / Консоль противовеса				13,11	2,42	0,57	2700
5	1	<b>Gegenausleger mit Hubwerkseinheit</b> / Counter-jib with hoist gear unit / Contre-flèche avec treuil de levage Controbraccio con gruppo meccanismo sollevamento / Contrapluma con mecanismo de elevación / Contra-lança com grupo de mecanismo elevatório / Консоль противовеса с блоком грузовой лебедки				13,11	2,42	2,20	7000
6	1	<b>Ausleger-Anlenkstück</b> / Jib heel section / Pied de flèche / Sezione articolata braccio / Pluma tramo primero / Base articulada de lança / Корневая секция стрелы				12,24	1,58	1,79	① 1970
7	1	<b>Ausleger-Zwischenstück</b> / Intermediate jib section / Élément intermédiaire de flèche / Sezione intermedia braccio / Tramo intermedio pluma / Peça complementar da lança / Промежуточная секция стрелы				12,30	1,25	1,70	③ 1380
8	2	<b>Ausleger-Zwischenstück</b> / Intermediate jib section / Élément intermédiaire de flèche / Sezione intermedia braccio / Tramo intermedio pluma / Peça complementar da lança / Промежуточная секция стрелы				10,30	1,25	1,70	② 1125 ④ 800
9	1	<b>Ausleger-Zwischenstück</b> / Intermediate jib section / Élément intermédiaire de flèche / Sezione intermedia braccio / Tramo intermedio pluma / Peça complementar da lança / Промежуточная секция стрелы				5,25	1,25	1,68	⑤ 370
10	1	<b>Ausleger-Kopfstück</b> / Jib head section / Pointe de flèche / Punta braccio / Tramo punta de pluma / Cabeça de lança / Концевая секция стрелы				6,51	1,43	1,88	⑥ 420
11	1	<b>Laufkatze und Lasthaken</b> / Trolley and hook / Chariot de distribution et crochet / Carrello con gancio / Carrito y gancho / Carro de ponte e gancho / Грузовая тележка и грузовой крюк				1,90	1,42	1,38	750

Pos. Item Rep. Voce Pos. Ref. Pos.	Anz. Qty. Qte. Qta. Cant. Cant. Кол-во				L (m)	B (m)	H (m)	kg*
<b>Turm</b> Tower / Mât / Torre Torre / Torre / Башня								
12	1	<b>Drehbühne und Turmspitze</b> / Slewing platform and tower head section / Ensemble mât-cabine et porte-fèche Piattaforma girevole e cuspid / Plataforma de giro y cabeza torre / Plataforma giratória e cabeça de torre Поворотная платформа и оголовок башни			132 HC 11,20 200 HC 11,70 290 HC 11,70	2,45 2,74 2,74	2,62 2,65 2,65	8370 8970 8970
13	1	<b>Ausleger- und Gegenausleger-Abspannung</b> / Jib and counter-jib suspension Haubanage de fèche et de contre-fèche / Attrezzatura di ancoraggio di braccio e controbraccio / Tirantes de sost en pluma y contrapluma / Grupo de ancoragem de lança e contra-lança / Расчал стрелы и консоли противовеса			8,20 5,87	0,55 0,20	0,12 0,16	915 170
14	15 11 12	<b>Turmstück</b> / Tower section Elément de mât / Elemento di torre Tramo torre / Torre / Башенная секция			132 HC 2,50 200 HC 4,14 290 HC 4,14	1,80 2,30 2,30	1,80 2,30 2,30	1090 2240 2300
15	7 3	<b>Turmstück lang</b> / Long tower section / Elément de mât long / Elemento di torre, lungo / Tramo de torre largo Peça de torre, comprida / Башенная секция, длинная			132 HC 5,0 132 HC 10,0 132 HC 12,5	1,80 1,80 1,80	1,80 1,80 1,80	1830 3430 4200
16	1	<b>Grundturmstück</b> / Base tower section / Mât de base / Elemento di torre base Tramo base / Peça de base de torre / Секция основания			132 HC 6,85 132 HC 10,00 200 HC 8,85 290 HC 8,85 (12,42)	1,80 1,80 2,30 2,30 (2,30)	1,80 1,80 2,30 2,30 (2,30)	2610 3530 4280 4830 (7940)
<b>Klettereinrichtung</b> Climbing equipment / Equipement de télescopage / Attrezzatura per allungamento della gru Equipo de trepado / Acessórios p. subida no edificio / Обойма наращивания								
17	1	<b>Führungsstück kpl.</b> / Guide section cpl. / Cage télescopique cpl. / Gabbia de sopraelevazione compl. Torre de montaje completa / Peça de guia compl. Направляющая секция в сб.			132 HC 6,45 132 HC 9,60 200 HC 8,39 290 HC 8,39	2,10 2,10 2,68 2,68	2,42 2,42 2,58 (3,04) 2,58 (3,04)	3500 4440 5200 5200
18	1	<b>Hydraulikanlage, Stütz- und Klettertraverse</b> / Hydraulic unit, supporting and climbing cross members / Système hydraulique avec traverses d'appui et de télescopage / Sistema idraulico, traversa di appoggio e allungamento gru Sistema hidráulico con traviesa de apoyo y trepado / Instalação hidráulica, travessa de apoio e subida / Гидроагрегат, стойка-упор и траверса обоймы наращивания			132 HC 2,87 200 HC 2,30 290 HC 2,30	2,12 1,25 1,25	1,06 1,00 1,00	1050 1150 1150
<b>Unterwagen</b> Undercarriage / Châssis / Carro Carro con mástil / Carro de guindaste / Опорная рама								
19	2	<b>Fahrschemel mit Antrieb</b> / Rail bogie with drive Bogie moteur / Telaio con gruppo propulsore Caja rodillo motriz / Quadro sem grupo de propulsão Подрамник с приводом			132 HC 1,38 200 HC 1,46 290 HC 1,63 (1,46)	0,88 0,84 0,92 (0,84)	0,87 0,87 0,95 (0,87)	900 920 1690 (920)
20	2	<b>Fahrschemel ohne Antrieb</b> / Rail bogie without drive Bogie fou / Telaio senza gruppo propulsore / Caja rodillo conducido / Quadro com grupo de propulsão Подрамник без привода			132 HC 1,17 200 HC 1,15 290 HC 1,37 (1,15)	0,60 0,60 0,62 (0,60)	0,87 0,87 0,95 (0,87)	860 880 1340 (880)
21	1	<b>Tragholm lang</b> / Long support arm / Longeron long Longherone lungo / Brazo soporte largo / Travessa comprida / Несущая балка, длинная			132 HC 7,12 200 HC 9,10 290 HC 9,10 (11,95)	0,78 0,82 0,80 (0,82)	0,65 0,74 0,80 (0,80)	950 1350 1650 (2200)
22	2	<b>Tragholm kurz</b> / Short support arm / Longeron court Longherone corto / Brazo soporte corto / Travessa curta / Несущая балка, короткая			132 HC 3,45 200 HC 4,41 290 HC 4,45 (5,58)	0,56 0,62 0,77 (0,65)	0,55 0,71 0,77 (0,77)	408 615 800 (1035)
23	2 + 2	<b>Randträger</b> / Border support / Traverse Supporti base / Traviesa / Apoio de bordo Стяжная балка			132 HC 4,02 200 HC 5,48 - 5,46 290 HC 5,46 - 5,40 (7,52 - 7,46)	0,35 0,11 - 0,17 0,11 - 0,18 (0,1 - 0,17)	0,12 0,16 - 0,38 0,16 - 0,38 (0,1 - 0,38)	95 118 - 454 175 - 525 (366 - 912)
24	4	<b>Stützhalm</b> / Support strut / Hauban de châssis Correnti di appoggio / Tirante vertical / Travessa de apoio / Опорный подкос			132 HC 3,78 200 HC 4,23 290 HC 4,14 (6,55)	0,15 0,17 0,18 (0,22)	0,22 0,25 0,25 (0,25)	200 275 320 (600)
25	1	<b>Unterwagen-Turmstück</b> / Undercarriage tower section / Mât de châssis / Elemento di torre del carro Tramo de carro / Peça de torre do chassis Опорная башенная секция			132 HC 3,50 200 HC 3,73 290 HC 3,73 (6,70)	2,06 2,52 2,62 (2,53)	2,06 2,52 2,62 (2,53)	1320 1950 2550 (3800)
26	1	<b>Stapel Aufstiege und Podeste</b> / Bundle of ladders and platforms / Faisceau d'échelles et de plates-formes / Serie di scale e rampe / Paquete de escadas y plataformas / Escadas e patamares / Лестницы и площадки			132 HC 3,50	1,20	1,00	1000
27	1	<b>Kiste mit Kleinteilen</b> / Crate with small parts / Caisse contenant des accessoires / Cassa con accessori / Caja con accesorios Caixa de acessórios / Ящик с мелкими деталями			2,00	1,00	1,00	2000

( ) **Angaben in Klammern gelten für 8 m-Unterwagen.** / The data in brackets are valid for an undercarriage of 8 m. / Les données techniques indiquées entre parenthèses sont valables pour un châssis de 8 m. / Caratteristiche in (.) valgono per carro di 8 m. / Los datos entre paréntesis son válidos para carro de 8 m. / Características em (.) válidas pelo chassis de 8 m. / Данные в скобках относятся к 8-метровой опорной раме

\* **Einzelgewichte.** / Single weights. / Poids individuels. / Singoli pesi. / Pesos unitarios. / Pesos de peças componentes. / Индивидуальный вес.

**Konstruktionsänderungen vorbehalten!** / Subject to alterations! / Sous réserves de modifications! / Riservato il diritto di modifiche strutturali!  
¡Sujeto a modificaciones! / Salvo modificação da construo! / Права на внесение конструкторских изменений сохраняются!

**Sämtliche Angaben erfolgen ohne Gewähr.** / This information is supplied without liability. / Ces renseignements sont sans garantie. / Tutte le indicazioni fornite senza garanzia. / Declinamos toda responsabilidad derivada de la información proporcionada. / Declinamos qualquer responsabilidade quanto à informação fornecida. / Все данные указаны без обязательств.